

## CLUTCH

### Clutch Adjustment

To adjust the clutch:

1. Make sure the ignition switch is OFF ( O ).
2. Loosen the lock nut (Fig. 4-16), and turn the clutch adjuster (2) counterclockwise until you feel slight resistance.
3. Then turn the adjuster 1/4 turn clockwise, and tighten the lock nut to hold the adjuster in this position.
4. After adjustment, start the engine and test ride the FOURTRAX to be sure the clutch is operating properly.

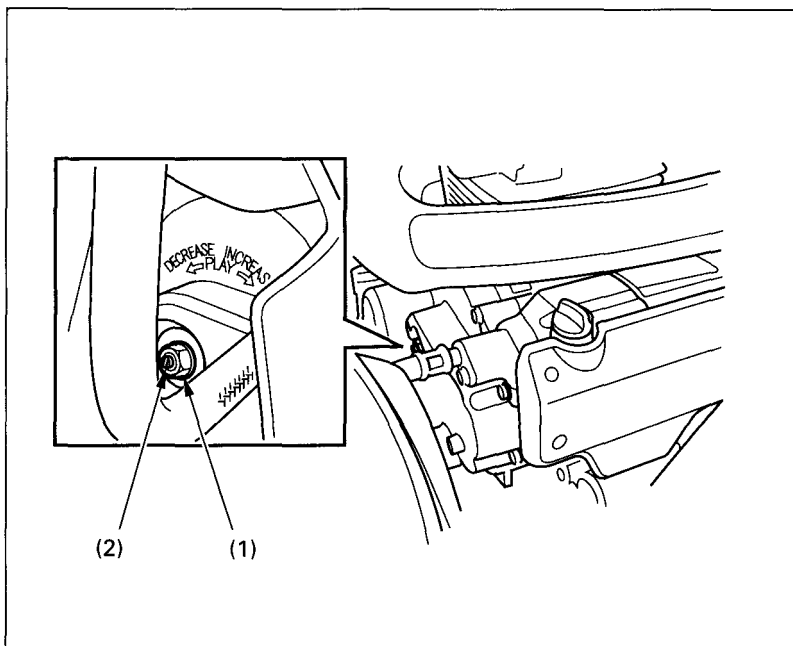

Fig. 4-16 (1) Lock nut

(2) Clutch adjuster